

Overflate stål: Varmgalvanisert eller pulverlakkert  
 Infestning: Bolteplate eller nedstøp

Rev	Beskrivelse	Dato	Tegnet av	Kontrollert av
	<b>Kraft</b>			Sign.
			Tegnet av	
			Kontrollert av	
			Godkjent av	
		Grenheimveien 7 1580 Rygge		Status <b>Produktblad</b>
		Prosj. nr.	Målestokk 1:3	
		Tegnr. <b>Sykelstativ</b>		Rev.

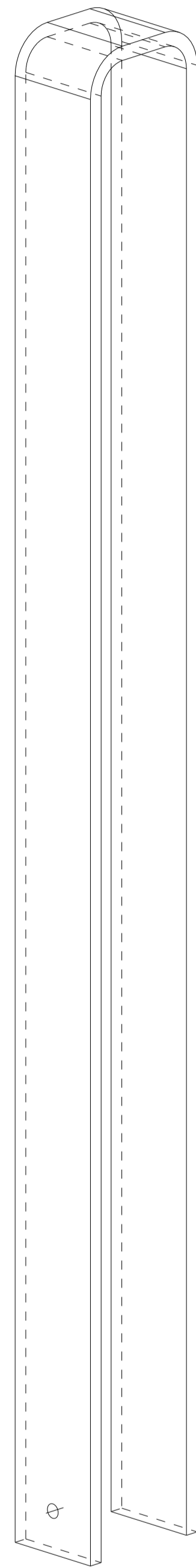

STANDARD  
1:3

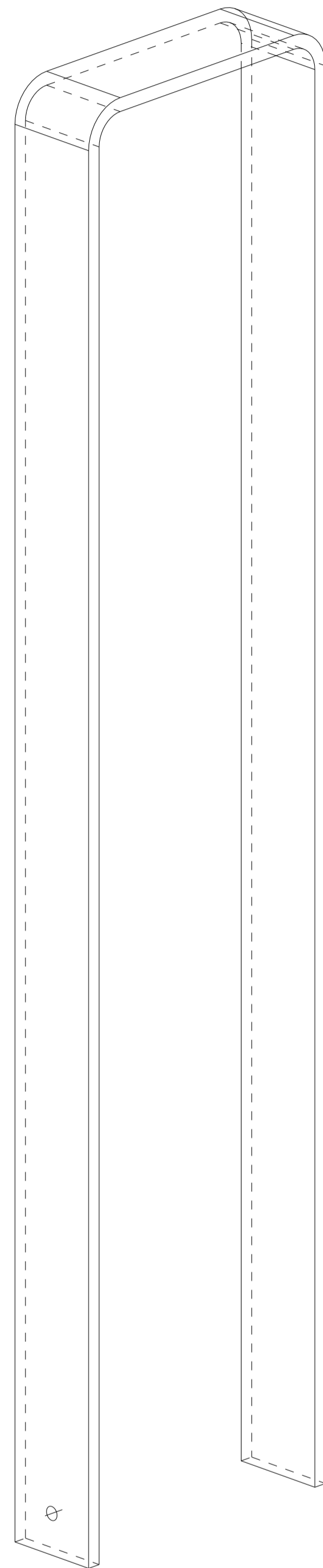

STANDARD  
1:3

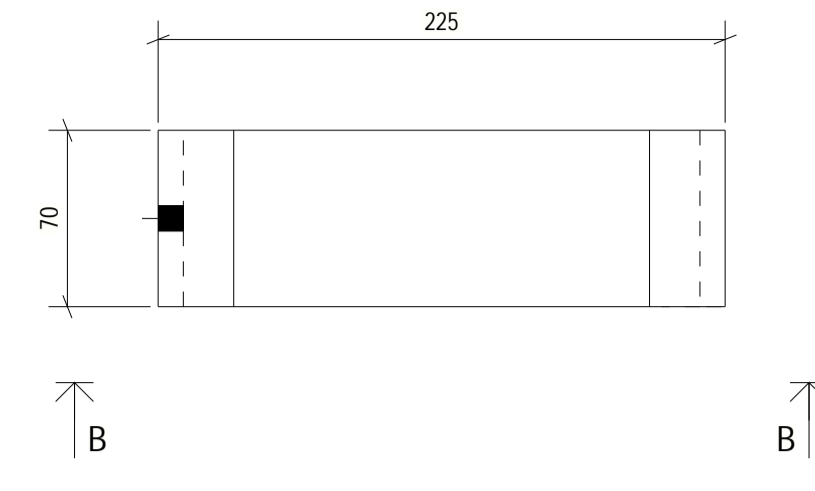
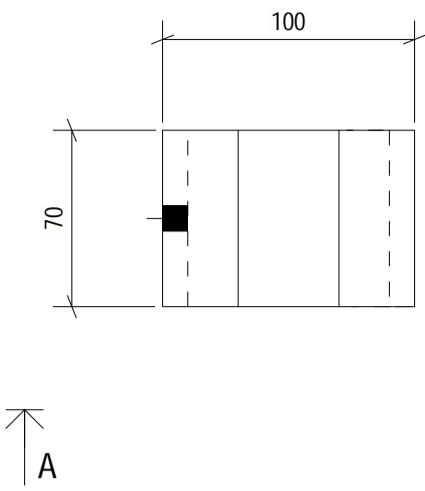

STANDARD  
1:3

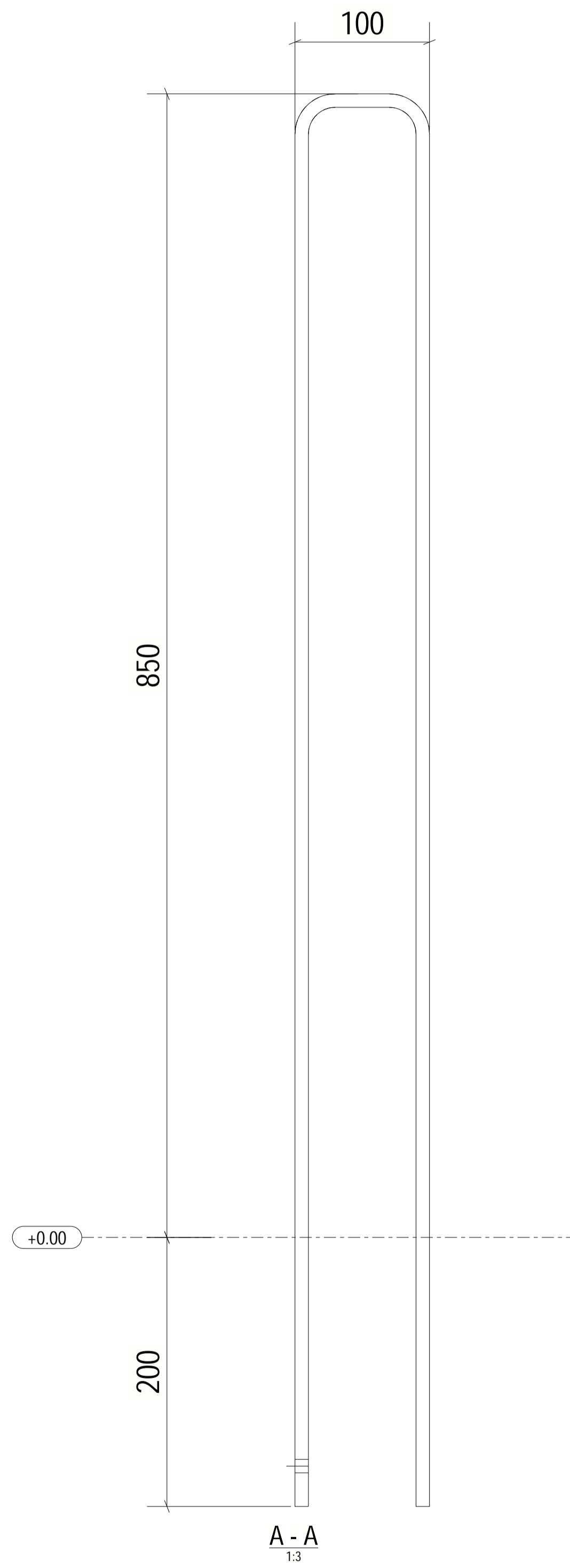

A - A  
1:3

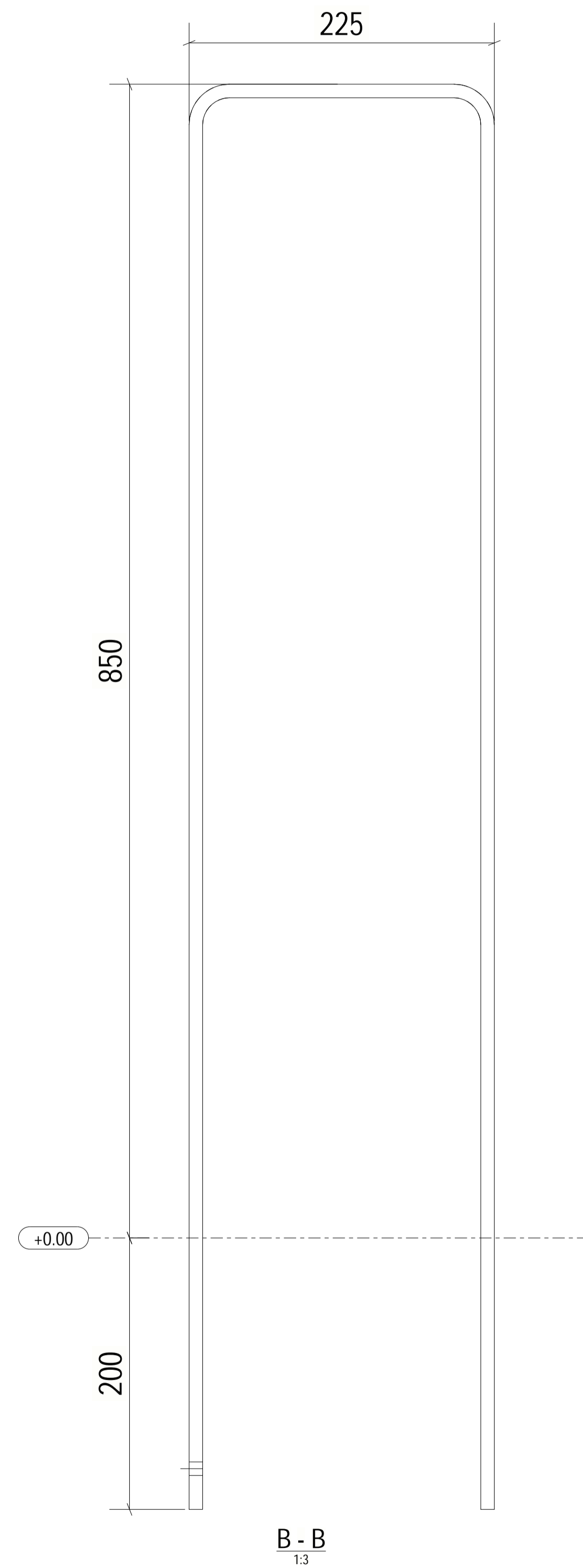

B - B  
1:3

Overflate stål: Varmgalvanisert eller pulverlakkert  
 Infestning: Bolteplate eller nedstøp

Rev	Beskrivelse	Dato	Tegnet av	Kontrollert av
	<b>Kraft</b>			
			Dato	Sign.
			Tegnet av	
			Kontrollert av	
			Godkjent av	
Status				
Granheimveien 7 1580 Rygge		Prosj. nr.	Målestokk 1:3	
post@ipoa.no www.ipoa.no		Tegn.nr.	Sykelstativ	Rev.