

Materiale:  
Flattstål

Overflatebehandling stål:  
Varmgalvanisert, pulverlakkert,  
cortenstål



Kraft Sykkelstativ  
100 - fotplate

1:20  
03.09.2024

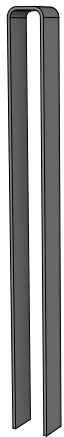
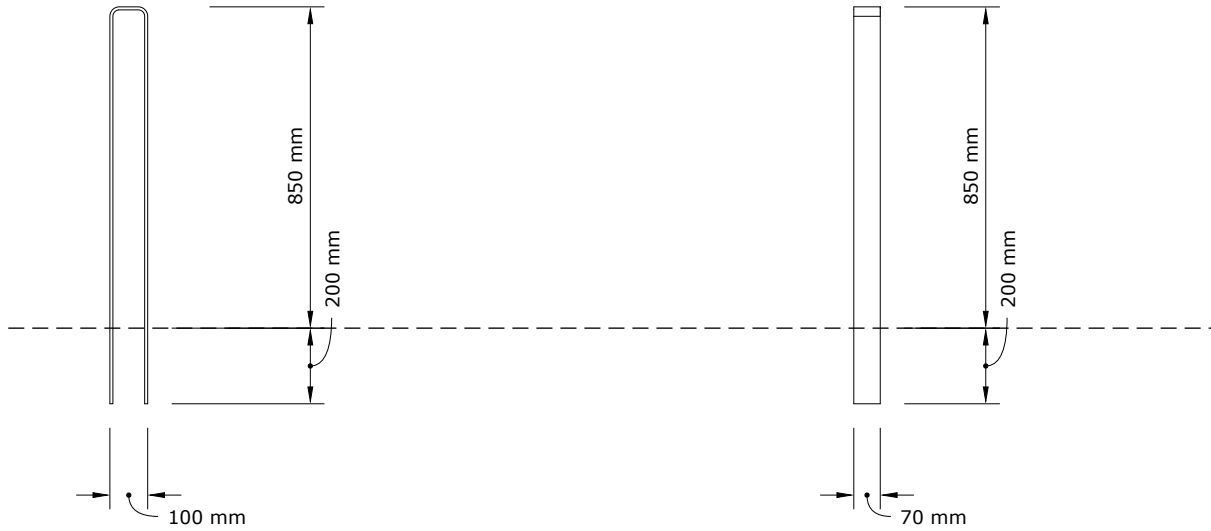
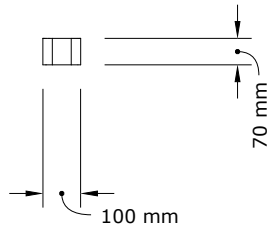

Materiale:  
Flattstål

Overflatebehandling stål:  
Varmgalvanisert, pulverlakkert,  
cortenstål



Kraft Sykkelstativ  
100 - nestøp

1:20  
03.09.2024

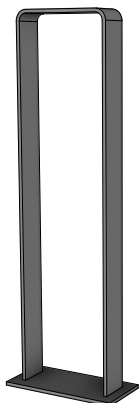
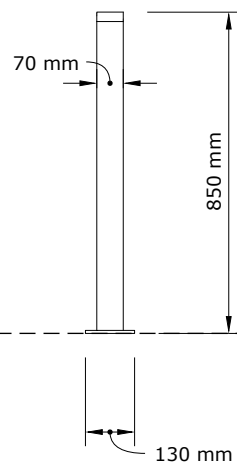
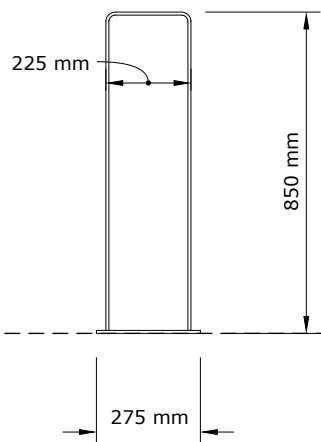
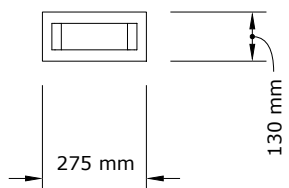

Materiale:  
Flattstål

Overflatebehandling stål:  
Varmgalvanisert, pulverlakkert,  
cortenstål



Kraft Sykkelstativ  
225 - fotplate

1:20  
02.09.2024

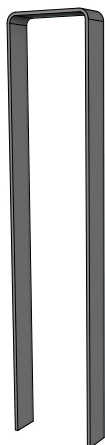
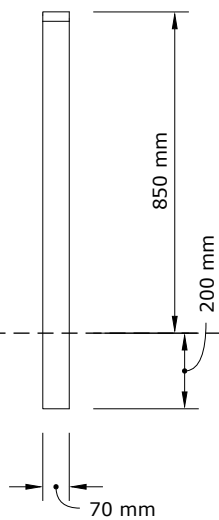
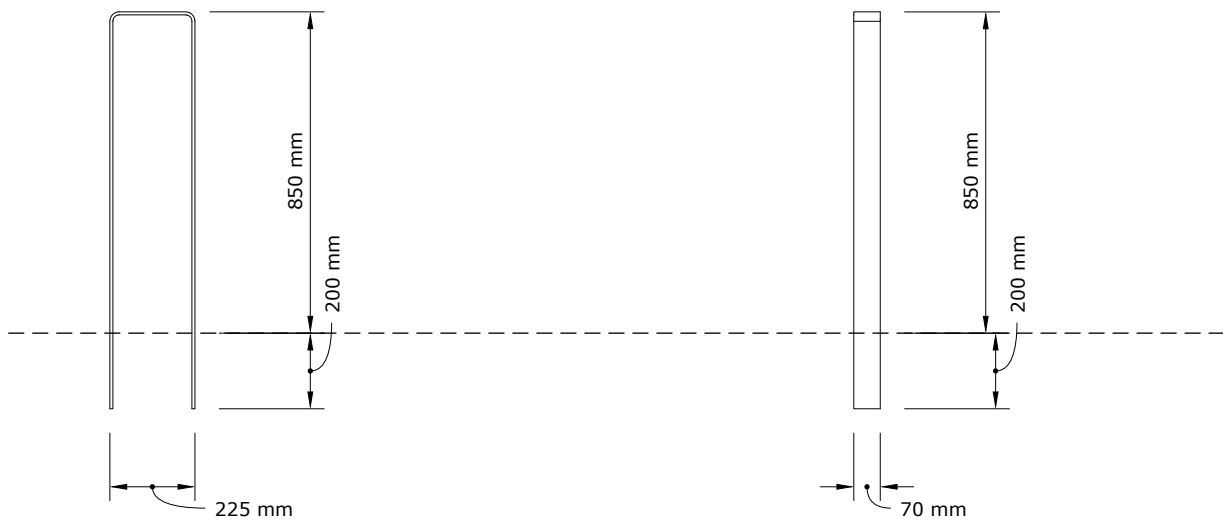
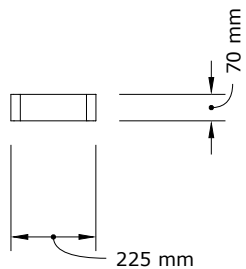

Materiale:  
Flattstål

Overflatebehandling stål:  
Varmgalvanisert, pulverlakkert,  
cortenstål



Kraft Sykkelstativ  
225 - nedstøp

1:20  
03.09.2024